



**2.4 GHz  
Cordless Telephone  
with Caller ID**

**CLT-2419  
CLT-2423**

Instruction Manual

**Important**

Charge the handset battery for 12 continuous hours prior to first use.

**SANYO Canada Inc.**

[www.sanyocanada.com](http://www.sanyocanada.com)

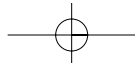

## TABLE OF CONTENTS

<b>INTRODUCTION</b> .....	<b>4</b>
<b>GETTING STARTED</b> .....	<b>5</b>
Checking package contents .....	5
Modular jack .....	5
Installation tips .....	5
Battery setup .....	6
Telephone line connection .....	6
Tone/pulse setting .....	6
Mounting on a wall .....	7
Digital Security System .....	7
<b>NAMES AND CONTROLS</b> .....	<b>8</b>
Handset .....	8
Base unit .....	9
<b>INITIAL PROGRAMMING</b> .....	<b>10</b>
Language .....	10
Screen contrast .....	10
Area code .....	11
Ringer tone .....	11
Time .....	11
Resetting to default .....	12
<b>BASICS</b> .....	<b>13</b>
Receiving a call .....	13
Making a call .....	13
Volume adjustment .....	14
Ringer switch and volume .....	15
Speakerphone use .....	15
Pre-dialing .....	16
Changing the pre-dial number .....	16
Redialing .....	16
Fast redialing .....	16
Switching between speaker phone and handset .....	16
Intercom and room monitoring .....	17
Using intercom while you are on a call .....	18
Conference calling .....	18
Conferencing after intercom conversation .....	19
FLASH key .....	19
CHAN (Channel) key .....	20
HOLD key .....	20
CANCEL key .....	20
TONE key .....	20
Handset locator (PAGE key) .....	20

## TABLE OF CONTENTS

MUTE key .....	21
Low battery warning .....	21
VOICE MAIL/IN USE indicator .....	21
<b>CALLER ID FEATURES</b> .....	<b>22</b>
Caller ID with Call Waiting .....	22
Caller ID list .....	22
Reviewing Caller ID list .....	23
Storing Caller ID entries in the directory .....	23
Dialing a Caller ID number .....	24
Deleting entries from the Caller ID list .....	24
<b>DIRECTORY</b> .....	<b>25</b>
Storing a name/number in the directory .....	25
Inserting a pause in the dialing sequence .....	26
Replacing a directory entry with a Caller ID entry .....	26
Changing a stored number .....	26
Making calls from the directory .....	26
Reviewing and deleting directory contents .....	27
Chain-dialing from the directory .....	27
<b>CHANGING THE BATTERY</b> .....	<b>28</b>
<b>RECYCLING NICKEL-METAL HYDRIDE BATTERIES</b> .....	<b>29</b>
<b>POWER FAILURE</b> .....	<b>29</b>
<b>HEADSET JACK AND BELT CLIP</b> .....	<b>29</b>
Headset connection .....	29
Belt clip installation .....	29
<b>LCD SCREEN MESSAGES</b> .....	<b>30</b>
<b>SOUND SIGNALS</b> .....	<b>31</b>
<b>TROUBLESHOOTING</b> .....	<b>31</b>
<b>MAINTENANCE</b> .....	<b>33</b>
<b>MAXIMIZE BATTERY PERFORMANCE</b> .....	<b>34</b>
<b>TECHNICAL INFORMATION</b> .....	<b>35</b>
<b>SANYO COMFORT WARRANTY</b> .....	<b>36</b>
<b>SOS HELP LINE</b> .....	<b>38</b>



The exclamation point within the triangle is a warning sign alerting you of important instructions accompanying the product.

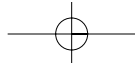

## INTRODUCTION

Congratulations on your purchase of this Sanyo cordless telephone.

Your Sanyo 2.4 GHz cordless telephone is a fine-quality home communications product. It is carefully designed and produced by a world leader of consumer and industrial electronics equipment. With proper maintenance and care, it will provide you with years of enjoyment and convenience.

### Main Features

#### 2.4 GHz Technology

**Superior Range** -The use of 2.4 GHz frequency band for signal transmission between base and handset means greater communication range compared to conventional 43 – 49 MHz cordless telephones.

**Ultra-Low Noise** -The high frequency communication has also significantly reduced noise level.

**40-Channel Auto Scan** -Your new telephone uses one of 40 channels in the 2.4-GHz frequency band. It automatically selects a clear channel every time you receive or place a call on the handset.

#### COMPANDER PLUS Noise Reduction

This fourth generation of the Sanyo's original noise reduction technology now filters out more background noise.

- Caller ID on Handset and base
- Speakerphone and dialing keypad on the base
- Compatible with Caller ID and Visual Call Waiting
- 40 name/number caller ID list: name/number, time and date
- 3-line trilingual display with backlit LCD screen
- Lighted handset keypad (CLT-2423 only)
- Dial back from Caller ID list

**IMPORTANT:** To use all of the features of this telephone, you must subscribe to either the standard Name/Number Caller ID Service or Caller ID with Call Waiting Service from your telephone company. To know who is calling while you are on the phone, you must subscribe to Caller ID with Call Waiting Service.

## GETTING STARTED

### Checking the package contents

Make sure your package includes the items shown here.



Base



Handset

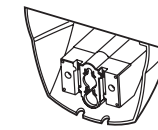

Wall mount bracket

AC adaptor  
(U120030D)Belt clip  
(CLT-2423 only)Replacement  
battery order  
formTelephone  
line cordHandset  
battery

### Modular jack

You need an RJ11 type modular phone jack. If you do not have a modular jack, call your local phone company to find out how to get one installed.

### Installation tips

Some cordless telephones operate at frequencies that may cause interference to nearby TVs, microwave ovens, and VCRs. To minimize or prevent such interference, the base of the cordless telephone should not be placed near or on top of a TV, microwave ovens, or VCR. If such interference continues, move the cordless telephone farther away from these appliances.

Certain other communications devices may also use the 2.4 GHz frequency for communication and if not set properly these devices may interfere with each other and/or your new telephone. If you are concerned with interference, please refer to the owner's manual for these devices on how to properly set channels to avoid interference. Typical devices that may use the 2.4 GHz frequency for communication include wireless audio/video senders, wireless computer networks, multi-handset cordless telephone systems, and some long-range cordless telephone systems.

## GETTING STARTED

### Battery setup

1. Remove the battery compartment cover on the handset, insert the battery, plug the cord into the jack (inside the compartment) and replace the cover.
2. Set the handset **RINGER** switch to **ON**, and place handset in the base.
3. Plug the AC adaptor into the **POWER DC 12V** jack on the back of base and the other end into an electrical outlet. The **CHARGE/PAGE** indicator comes on verifying the battery is charging.

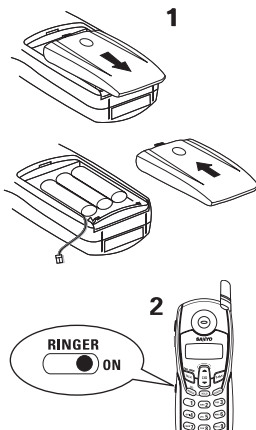

Charge the handset for 12 continuous hours prior to first use. The initial battery charge is important for best performance.

**Note:** It is normal for the handset and base to get warm when the handset is charging in the base.

**Note:** For desktop charging only, the handset is able to charge facing up or down.

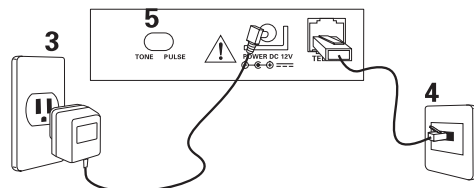

### Telephone line connection

4. Plug the telephone line cord into the **TEL LINE** jack on the back of the base and into a modular phone jack.

### Tone/pulse setting

5. If you have PULSE (rotary) telephone line, set the **PULSE/TONE** switch on the back of the base to **PULSE**. For touch-tone service line, do nothing as your phone has been set to **TONE** at factory. If you do not know which type of service you have, contact your local telephone company.

**Caution:** Use only the Sanyo AC adaptor (U120030D) that is supplied with this phone. Using another AC adaptor may damage the phone.

## GETTING STARTED

### Mounting on a wall

Do not attempt to wall-mount the phone before initial 12-hour charging is completed.

Follow steps 1–3 above to charge the handset.

4. Remove the handset from the base and set aside. Turn the base over and align the four slots on the bottom of the base with the four hook-tabs on the bracket.
5. Insert the hook-tabs into the slots and push up until the bracket snaps securely into place.
6. Plug the telephone line cord into the **TEL LINE** jack on the back of the base and into a modular phone jack.

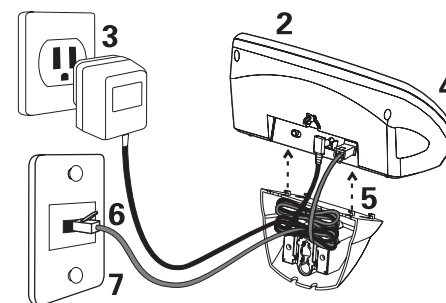

**Note:** If you have PULSE (rotary) telephone line, set the **PULSE/TONE** switch on the back of the base to **PULSE**.

7. Slip the mounting holes over the wall plate posts and slide the unit down firmly into place. (Wall plate not included.)
8. Place the handset in the base.

**Note:** If desired, gather the extra AC adaptor cord and telephone line cord together, fasten with a wire tie, and store inside the wall mounting bracket.

### Digital Security System

Your cordless phone uses a digital security system to provide protection against false ringing, unauthorized access and charges to your phone line. When you place the handset in the base, the phone verifies its security code. After a power outage or battery replacement, you should place the handset in the base for about 20 seconds to reset the code.

## NAMES AND CONTROLS

### Handset

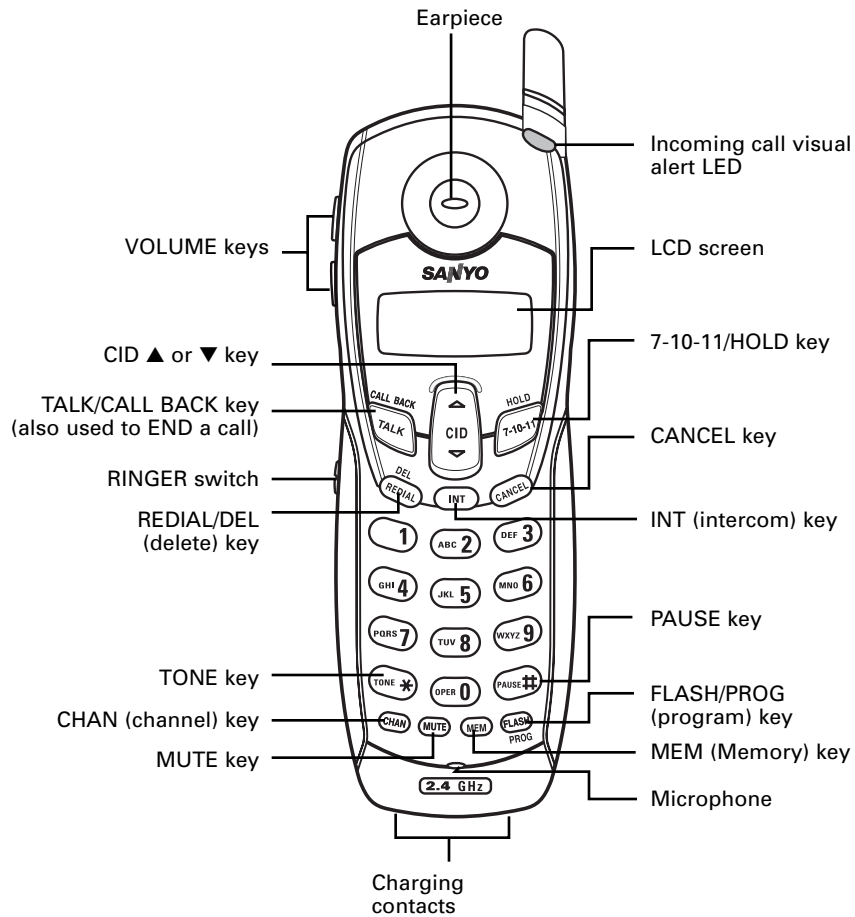

## NAMES AND CONTROLS

### Base unit

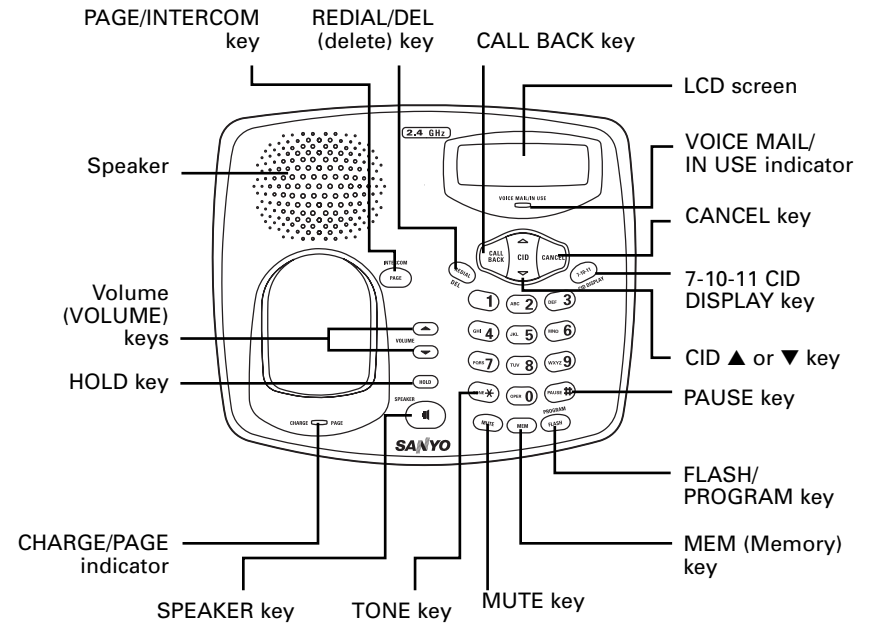

TONE/PULSE selection switch is located on the back of the base unit.

## INITIAL PROGRAMMING

Before using this telephone 6 initial settings must be completed on the base: Language, Screen contrast, Area code (This is required to use Caller ID service from your telephone company), Ringer tone and Time.

**Note:** The Language selection and Ringer tone setting must be done separately for the handset and for the base.

### Language setting

#### *On the base:*

1. Make sure the phone is OFF (not in TALK mode).
2. Press **FLASH/PROGRAM** on the base.  
**1 ENGLISH 2 FRA 3 ESP** shows on screen.
3. Press **CID ▲** or **▼**, or the number keys to select the desired language.
4. Press **FLASH/PROGRAM** to confirm.

#### *On the handset:*

1. Make sure the phone is OFF (not in TALK mode).
2. Press **FLASH/PROG** on the handset.  
**1 ENGLISH 2 FRA 3 ESP** shows on screen.
3. Press **CID ▲** or **▼**, or the number keys to select the desired language.
4. Press **FLASH/PROG** to confirm.

### Screen contrast setting

To adjust the base screen only.  
The handset screen is not adjustable.

1. Make sure the phone is OFF (not in TALK mode).
2. Press **FLASH/PROGRAM** twice.  
**SET CONTRAST** shows on screen.
3. Press **CID ▲** or **▼**, or the **1** or **2** number key to select the desired contrast.
4. Press **FLASH/PROGRAM** to confirm.

## INITIAL PROGRAMMING

### Area code setting

For proper Caller ID operation, you must enter your area code. This setting can only be done from the base.

1. Make sure the phone is OFF (not in TALK mode).
2. Press **FLASH/PROGRAM** three times.  
**SET AREA CODE** shows on screen.
3. Enter your 3-digit area code using the number keys.
4. Press **FLASH/PROGRAM** to confirm.

### Ringer tone setting

#### *On the base:*

1. Make sure the phone is OFF (not in TALK mode).
2. Press **FLASH/PROGRAM** four times. **SET RINGER TONE** shows on the screen.
3. Press **CID ▲** or **▼**, or press the **1**, **2**, or **3** number keys to select the desired ringer tone.
4. Press **FLASH/PROGRAM** to confirm.

#### *On the handset:*

1. Make sure the phone is OFF (not in TALK mode).
2. Press **FLASH/PROG** two times.  
**SET RINGER TONE** shows on the screen.
3. Press **CID ▲** or **▼**, or press the **1**, **2**, or **3** number keys to select the desired ringer tone.
4. Press **FLASH/PROG** to confirm.

### Time setting

The time and date are programmed automatically when Caller ID information is successfully received after setup.

1. Phone must be OFF (not in TALK mode).
2. Press **FLASH/PROGRAM** on the base five times.  
**SET TIME** shows on the screen.
3. Enter the hour and minutes using the number keys (**0 – 9**).
4. Press **CID ▲** or **▼** key to select AM or PM.
5. Press **FLASH/PROGRAM** to confirm.

## INITIAL PROGRAMMING

### Resetting to default

You can reset the phone programming to the initial factory default settings.

The default settings are:

Language - **English**

Contrast - **2**

Area Code - **\_ \_ \_**

Ringer Tone - **Ringer Tone 1**

Time Set - **12:00 AM**

Default Set - **2 NO**

1. Make sure the phone is OFF.
2. Press **FLASH/PROGRAM** on the base six times.  
**DEFAULT SETTING 1YES 2NO** shows on screen.
3. Press **CID ▲** or **▼**, or the **1** or **2** key to select your choice.
4. Press **FLASH/PROGRAM** to confirm.

## BASICS

### Receiving a call

When an incoming call is received, both handset and base screens light and show caller information\*. The incoming call LED on the handset and the **SPEAKER** key on the base flash.

\* A subscription is required from your local phone company to receive Caller ID information on your phone. See **Caller ID Features**, page 22.

#### Using handset:

1. Press **TALK/CALL BACK** to answer the call.  
**Note:** If handset is in the base cradle, remove it from base before pressing the **TALK/CALL BACK** key.
2. Press **TALK/CALL BACK** again to hang up.  
**Note:** If you replace the handset to the base cradle, the handset automatically hangs up.

#### Using base speakerphone:

1. Press **SPEAKER** to answer the call.
2. Press **SPEAKER** again to hang up.

### Making a call

#### Using handset:

1. Press **TALK/CALL BACK**.  
**Note:** If handset is in the base cradle, remove it from base before pressing the **TALK/CALL BACK** key.
2. Dial the phone number.  
The screen shows the number as you enter.

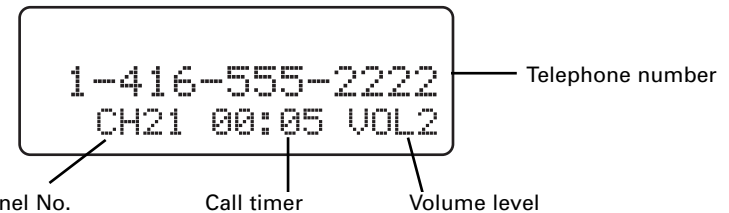

3. Press **TALK/CALL BACK** again to hang up.

## BASICS

### Using base speakerphone:

1. Press **SPEAKER**.
2. Dial the phone number.  
The screen shows:

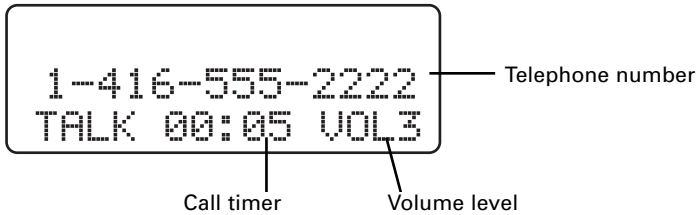

3. Press **SPEAKER** again to hang up.

### Volume adjustment

The **VOLUME** keys on the handset adjusts the volume level of the handset's earpiece. The **VOLUME** keys on the base controls the base speaker. There are four levels.

### Speakerphone volume

1. Make sure the speakerphone is ON (**SPEAKER** key is lit).
2. Press **VOLUME ▲** or **▼**, on the base. The volume level shows on screen.

### Handset volume

1. Make sure the handset is in TALK mode.
2. Press the **VOLUME ▲** or **▼** key on the side of the handset.  
The volume level shows on screen.

## BASICS

### Ringer switch and volume

#### Handset ringer:

The **RINGER** switch must be on for the handset to ring during incoming calls.

#### Base ringer:

1. Make sure the speakerphone is OFF (**SPEAKER** key is not lit).
2. To increase the ringer volume to the highest level, press **VOLUME ▲**.
3. To decrease the ringer volume level, press **VOLUME ▼**.
4. To turn off the ringer, press **VOLUME ▼** until **RINGER OFF** shows on screen.

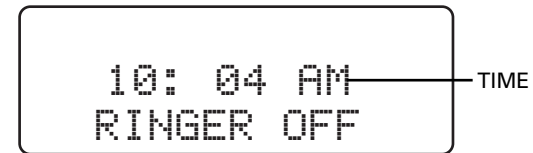

### Speakerphone use

#### For best speakerphone performance, avoid the following:

- Areas with high background noise. (The microphone might pick up these sounds and prevent the speakerphone from going into the receiving mode when you finish talking.)
- Surfaces affected by vibration.
- Recessed areas such as in a corner, under a cupboard, or next to a cabinet, which can generate an echo effect.

#### Tips:

- The speakerphone works similar to a 2-way radio. You can only listen or talk one at a time.
- Stay reasonably close to the phone so you can be heard clearly.
- The **SPEAKER** key lights up when the speakerphone is in use.



## BASICS

### Pre-dialing

1. Make sure the phone is OFF (not in TALK mode).
2. Enter the telephone number. The telephone number shows on screen.
3. Press **TALK/CALL BACK** on the handset or press **SPEAKER** or **CALL BACK** on the base. The telephone number shows on the respective screen.

**Note:** You may enter up to 32 pre-dial digits.

### Changing the pre-dial number

1. Make sure the phone is OFF (not in TALK mode).
2. Enter the telephone number.
3. Press **REDIAL/DEL** to delete digits one by one.
4. Re-enter the number.

### Redialing

1. Make sure the phone is OFF (not in TALK mode).
2. Press **TALK/CALL BACK** on the handset or **SPEAKER** on the base.
3. Press **REDIAL/DEL** to redial the last number (up to 32 digits).

### Fast redialing

1. Press **TALK/CALL BACK** on the handset or **SPEAKER** on the base.
2. Enter the telephone number you want to dial.  
If the line is busy, press **REDIAL/DEL**. The phone will drop the line for two seconds and redials the number.

### Switching between speakerphone and handset

You can switch between speakerphone and handset after dialing a number or anytime during a conversation.

- **Speakerphone to handset** – When the speakerphone is on press **HOLD** to put the caller on hold, and then remove the handset from the cradle on the base. You are automatically connected to the caller.  
**Note:** If the handset is already off the cradle when you put the call on hold, press **TALK/CALL BACK** to connect to the caller.

## BASICS

- **Handset to speakerphone** – When the handset is in talk mode press **HOLD** to put the caller on hold, and then place the handset in the base. You are automatically connected to the caller through the speakerphone.

### Intercom and room monitoring

The intercom feature of your cordless phone allows you to have a 2-way conversation between the handset and the base unit without tying up the telephone line. Since the telephone line is not being used, you can still receive incoming calls. You can also use this feature for room monitoring.

#### From the handset:

1. Make sure the phone is OFF (not in TALK mode).
2. Press **INT** on the handset. A paging tone sounds at the base and from the handset. **PAGING** shows on screen. (To cancel intercom, press **INT** again.)
3. Wait for the person near the base to press **PAGE/INTERCOM**. If no one presses the key from the base within 15 seconds, the base enters intercom mode automatically.
3. When finished, press **INT** on the handset or **PAGE/INTERCOM** on the base to stop using the intercom.

**Note:** The base must be within range of the handset for the intercom to function. If the base is in use, **BASE IN USE** shows on the handset screen.

#### From the base:

1. Make sure the phone is OFF (not in TALK mode).
2. Press **PAGE/INTERCOM**. A paging tone sounds at the handset and base. (To cancel intercom, press **PAGE/INTERCOM** again.) **PAGING** shows on screen.
3. Wait for the person with the handset to press **INT**. **INTERCOM** shows on screen.
4. When finished, press **PAGE/INTERCOM** on the base (or **INT** on the handset) to stop using the intercom.

**Note:** The handset must be within range of the base unit in order for intercom to function. If the handset is in use, you will hear 3 soft beeps from the base unit.

## BASICS

### Using the intercom while you are on a call

You may want to use the intercom feature while you are on a call.

#### *From the handset (in TALK mode):*

1. Press **INT** on the handset. The line is put on hold, and you will hear a paging tone at the base and handset.
2. Press **PAGE/INTERCOM** on the base and **INTERCOM** shows in the handset screen.
3. Press **INT** on the handset to return to TALK mode.

#### *From the base (in speakerphone mode):*

1. Press **PAGE/INTERCOM** on the base. The line is put on hold, and you will hear a paging tone at the base and handset.
2. Press **INT** on the handset and **INTERCOM** shows in the base screen.
3. Press **PAGE/INTERCOM** on the base to return to TALK mode.

**Note:** When the handset is holding a call on intercom, you may transfer the call to the base by pressing **TALK/CALL BACK** on the handset. When the base is holding a call in the intercom, you may transfer the call to the handset by pressing **SPEAKER** on the base.

### Conference calling

You can use the speakerphone and handset at the same time for a 3-way conversation with a third party.

#### *Conferencing from the base:*

1. Press **SPEAKER**.
2. Dial the number you want to call. The number shows on screen.
3. Press **TALK/CALL BACK** on the handset. **CONFERENCE** shows on the base and handset screens.
4. When finished, press **TALK/CALL BACK** on the handset and **SPEAKER** on the base.

**Tip:** If you want to hang up the handset and continue talking on the speakerphone, press **TALK/CALL BACK**.

## BASICS

### *Conferencing from the handset:*

1. Press **TALK/CALL BACK**.
2. Dial the number you want to call. The telephone number shows on screen.
3. Press **SPEAKER** on the base. **CONFERENCE** shows on the base and handset screens.
4. When finished, press **TALK/CALL BACK** on the handset and **SPEAKER** on the base.

**Tip:** If you want to hang up the speakerphone and continue talking on the handset, press **SPEAKER**.

### Conferencing after the intercom conversation

#### *From the base:*

1. Press **SPEAKER** to speak to the caller.
2. Press **PAGE/INTERCOM** on the base to put the caller on hold. **PAGING** and **HOLD** shows on screen.
3. Press **INT** on the handset. **INTERCOM** shows on screen. You can have an intercom conversation with the handset user.
4. Press **TALK/CALL BACK** on the handset. **CONFERENCE** shows on screen. Start 3-way conference conversation.

#### *From the handset:*

1. Press **TALK/CALL BACK** to speak to the remote party.
2. Press **INT** on the handset to put the caller on hold. **PAGING** and **HOLD** shows on screen.
3. Press **PAGE/INTERCOM** on the base. **INTERCOM** shows on screen.
4. Press **SPEAKER**. **CONFERENCE** shows on screen. Start 3-way conference conversation.

### FLASH key

Use the **FLASH/PROGRAM** key on the handset or base to activate custom calling services such as Call Waiting or Call Transfer, which are available through your local phone company.

## BASICS

**Tip:** Do not use **TALK/CALL BACK** (or **SPEAKER** on base) to activate custom calling services such as Call Waiting, or you will hang up the phone.

### CHAN (Channel) key

While talking, you might need to manually change the channel in order to get rid of static. Press and release the **CHAN** key on the handset to switch to the next clear channel.

### HOLD key

Press **HOLD** on the handset or base to put a call on hold. To release a line on hold, press **HOLD** again or pick up an extension phone.

**Note:** If you are using the handset, the incoming call indicator flashes. If you are using the speakerphone the **SPEAKER** key flashes.

### CANCEL key

Press **CANCEL** to cancel certain commands you initiated. Press **CANCEL** to hang up after finishing a call.

### TONE key

This feature enables Pulse service phone users to access touch-tone services offered by banks, credit card companies, etc.

1. Call the bank's information line.
2. Press **TONE** after your call is answered.
3. Follow the voice instructions to complete your transaction.
4. Hang up when finished. The phone returns to Pulse service.

### Handset locator

This feature helps to locate a misplaced handset.

Press and release **PAGE/INTERCOM** on the base. The screen shows **PAGING**. The handset beeps continuously for about 2 minutes or until you press any key on the handset.

**Note:** You can still page the handset with the ringer off.

## BASICS

### MUTE key

To have a private, off-line conversation, use the MUTE feature. The caller on the other end of the line cannot hear you, but you can still hear them.

#### To mute the microphone:

1. Press **MUTE** on the handset or the base.
2. Press **MUTE** again to return to your phone conversation. If you are using the handset, the incoming call indicator flashes. If you are using the speakerphone, the **MUTE** key on the base flashes. **MUTE** shows in either screen.

### Low battery warning

If the battery is low, a warning tone consisting of 4 short beeps will sound from the handset when in TALK mode. **LOW BATTERY** shows on screen.

### VOICE MAIL/IN USE indicator

- Flashes when you have a new voice mail
- Lights when the handset is in use.

When you subscribe to a voice mail service offered by your phone company, the phone alerts you when voice mail has been received. **MESSAGE WAITING** appears on screen for 60 seconds when a voice mail is received. The **VOICE MAIL/IN USE** indicator on the base flashes to indicate there is a voice mail waiting. After the voice mail has been reviewed **MSG WAITING OFF** appears on screen and the **VOICE MAIL/IN USE** indicator stops flashing.

- This indicator does not work with your answering machine.

**Note:** The phone will only work with an FSK type of VMWI system. It will not work with the Stutter Dial Tone type of VMWI system.

## CALLER ID FEATURES

This phone receives and displays incoming call information transmitted by your local phone company. This information can include the phone number and/or the name, date and time. The phone can store up to 40 calls for later review.

### Caller ID with Call Waiting

When you subscribe to Caller ID with Call Waiting (Visual Call Waiting™) service from your phone company, you are able to see who is calling when you hear the Call Waiting beep. Caller identification information appears on screen after you hear the tone.

- Press the **FLASH/PROGRAM** key to put the current call on hold so that you can answer the incoming call.

**IMPORTANT:** To use these features you must subscribe to either the standard Name/Number Caller ID Service or Caller ID with Call Waiting Service.

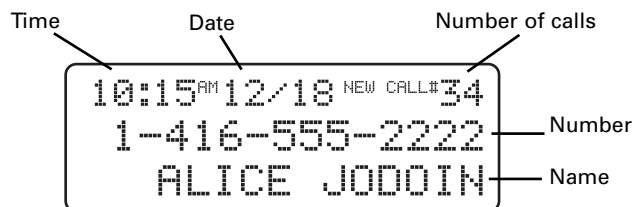

### Caller ID list

The incoming caller information transmitted from the phone company is received by your phone between the first and second rings and stored in the Caller ID list. If you answer a call before the second ring the caller information may not be stored.

When the Caller ID list memory is full, a new call automatically replaces the oldest call in memory. **NEW** appears on screen for calls received that have not been reviewed.

**Note:** Check with your local phone company regarding name service availability.

**Important:** You cannot receive Call Waiting Caller ID information while using the conference features.

## CALLER ID FEATURES

### Reviewing Caller ID list

As calls are received and stored, the screen is updated to let you know how many calls have been received.

- Press **CID ▼** to scroll through the Caller ID list from the most recent to the oldest. You can also use the **CID ▲** or **▼** key on the base.
- Press **CID ▲** to scroll through the Caller ID list from the oldest to the most recent.

**Note:** You may also transfer Caller ID entries to the directory. See *Storing caller ID entries in directory* below.

### Storing Caller ID entries in the directory

Before storing a caller ID number, make sure the number appears in proper digits for your dialing area. If not, change it using the **7-10-11** key. For example, if the Caller ID number appears **1-416-222-5555** but it is not a long distance number, press the **7-10-11** key until it shows **416-222-5555** (without 1).

The **7-10-11** key (or **7-10-11/HOLD** key on the handset) lets you select how many digits of the number are displayed:

- 7** 7-digit telephone number.
- 10** 3-digit area code + 7-digit telephone number.
- 11** Long distance code 1 + 3-digit area code + 7-digit telephone number.

**Note:** If a specific memory entry is longer than 15 digits, the first 15 digits show on the screen. To view the remaining digits, press **7-10-11**.

- Use the **CID ▲** or **▼** key to select desired Caller ID entry.
- Press **MEM. SELECT MEMO 1-0** shows on the screen.
- Enter a location number.
- If the memory location already contains Caller ID information, and you want to replace the information, press **MEM** again. **REPLACE MEMO?** shows on screen.
- Press **MEM** again to confirm and save.

## CALLER ID FEATURES

### Dialing a Caller ID number

1. Make sure the phone is OFF (not in TALK mode).
2. Use **CID ▲** or **▼**, to scroll to the desired Caller ID entry.
3. Use the **7-10-11** key to show the phone number in proper digits if necessary.
4. Press the **TALK/CALL BACK** on the handset or **CALL BACK** on the base. The number dials automatically.

### Deleting entries from the Caller ID list

Use **REDIAL/DEL** to erase the entry currently shown on screen or all entries.

**Note:** Deleting Caller ID entries on the handset and base is done separately.

### Deleting the displayed entry

1. Make sure the phone is OFF (not in TALK mode).
2. Use the **CID ▲** or **▼** keys to find the entry you want to delete.
3. While the entry is displayed, press **REDIAL/DEL**. **DELETE?** shows on screen.
4. Press **REDIAL/DEL** again to delete the entry.

### Deleting all entries

1. Make sure the phone is OFF (not in TALK mode).
2. Use the **CID ▲** or **▼** keys to display any entry.
3. Press and hold **REDIAL/DEL**. **DELETE ALL?** shows on screen.
4. Press **REDIAL/DEL** again to erase all entries. **NO CALLS** shows on screen.

## DIRECTORY

You may store up to 20 numbers (up to 24-digits) in memory for quick dialing.

The directory locations for the base and handset are separate, with 10 memory locations for each. This directory feature is in addition to the 40 Caller ID list.

### Storing a name/number in the directory

The phone must be OFF (not in TALK mode).

1. Press **MEM**.  
**MEMO #** and **SELECT MEMO 1-0** shows on screen.
2. Press the desired memory location (0 through 9) or use the **CID ▲** or **▼** keys to find an empty memory location.
3. Press **MEM**. The screen shows **ENTER NAME**.
4. For example, to enter the name Alice Roy:  
Press the **2** key once for the letter A.  
Press the **5** key 3 times for the letter L.  
Press the **4** key 3 times for the letter I.  
Press the **2** key 3 times for the letter C.  
Press the **3** key twice for the letter E.  
Press the **1** key to insert a space between the letter E and R.  
Continue to enter the letters of the last name.  
**Note:** The cursor will automatically move to the next position when another number key is pressed.
5. Press **MEM** to save the name.
6. Press **MEM** again.  
The screen shows **MEMO #** and **ENTER TEL NUMBR**.
7. Use the number keypad to enter the telephone number you want to store (up to 24 digits). **MEMO #** and the telephone number you want to store show on screen.
8. Press **MEM** again to store the number.

To view your directory, press **MEM** and use **CID ▲** or **▼** to scroll.

## DIRECTORY

### Inserting a pause in the dialing sequence

Press **PAUSE** twice to insert a delay in the dialing sequence of a stored telephone number when a pause is needed to wait for a dial tone (for example after you dial 9 for an outside line, or to wait for a computer access tone). Each pause counts as 1 digit in the dialing sequence. **P** shows on screen.

Note: Make sure to press **PAUSE** twice to enter a pause. If you press **PAUSE** once while entering a directory name/number, it will enter a # (number sign).

### Replacing a directory entry with a Caller ID entry.

1. Use **CID ▲** or **▼** to select a specific Caller ID entry.
2. Press **MEM**.  
**SELECT MEMO 1-0** shows on screen.
3. Select the memory location you want to replace and press **MEM**.  
**REPLACE MEMO?** shows on screen.
4. Press **MEM** again to confirm and save.

### Changing a stored number

Use the same procedure as you do to store a name/number in the directory.

### Making calls from the directory

1. Make sure the phone is OFF (not in TALK mode).
2. Press **MEM**.
3. Use **CID ▲** or **▼**, to scroll to the desired memory location.
4. Press **TALK/CALL BACK** on the handset or **CALL BACK** on the base.

or

1. Make sure the phone is ON by pressing **TALK** on the handset or **SPEAKER** on the base.
2. Press **MEM**.
3. Press a number (**0 – 9**) for the desired memory location.  
The number dials automatically.

## DIRECTORY

### Reviewing and deleting directory contents

1. Make sure the phone is OFF (not in TALK mode).
2. Press **MEM**.
3. Use **CID ▲** or **▼** to scroll through the directory until the desired name/number is shown, or use the number pad to select a memory location. **MEMO #**, the selected telephone number and name show on screen.
4. While the entry is displayed, press **REDIAL/DEL** to delete the entry. The screen shows **DELETE?**
5. Press **REDIAL/DEL** again to delete the entry. **DELETED** shows on screen.

### Chain dialing from the directory

Use this feature to make calls that require a sequence of numbers such as using a calling card for a frequently called long distance number. You can dial each part of the sequence from a different entry of the directory. The following example shows how you can use chain dialing to make a call through a long distance service:

The Number for:	Memory Location
Long distance access number	7
Authorization code	8
Frequently called long distance number	9

1. Make sure the phone is in TALK mode.
2. Press **MEM** and then press **7**.
3. When you hear the access tone, press **MEM** and then press **8**.
4. At the next access tone, press **MEM** and then **9**.

**Tip:** Wait for the access tones before pressing the next memory key, or your call might not go through.

## CHANGING THE BATTERY

### Battery replacement and handling

When the operating time becomes short even after a battery is recharged, please replace the battery.

With normal usage, your battery should last about one year.

For a replacement battery, please contact your place of purchase or fill out and mail the enclosed Battery Order form.

#### Caution:

- Use only the specified battery type (3.6 V, 600 mAh).
- Do not remove the battery from the handset to charge it.
- Never throw the battery into a fire, disassemble it, or heat it.
- Do not remove or damage the battery casing.
- Remove battery if storing the phone over 30 days.

### Make sure the telephone is off before you replace the battery.

1. Slide off the battery compartment cover.
2. Disconnect the battery plug from the jack in the compartment and remove the battery pack.
3. Insert the new battery pack and connect the cord into the jack.
4. Put the battery compartment cover back on.
5. Place handset on the base to charge for 12 hours.

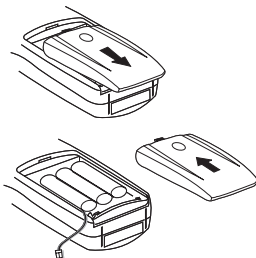

**Note:** If the handset battery is removed for more than 5 minutes, the directory memory and Caller ID memory will be erased.

Charge the handset battery for 12 continuous hours prior to first use. The initial battery charge is important for best performance.

**Caution:** To reduce the risk of fire or personal injury, use a 3.6 V, 600 mAh battery. Replacement part number: GES-3AHRAAAU.

## RECYCLING NICKEL-METAL HYDRIDE BATTERIES

NICKEL-METAL HYDRIDE BATTERIES MUST BE DISPOSED OF PROPERLY.

Please take your used battery pack to a store that recycles Ni-MH batteries.



## POWER FAILURE

During the period that the power is off, you will not be able to make or receive calls with the telephone.

After a power outage, place the handset in the base for about 20 seconds to reset the digital security code.

## HEADSET JACK AND BELT CLIP

### Headset connection (Headset not included)

For hands free conversation, connect the headset (not included) to the **HEADSET** jack. The handset earpiece and microphone are disabled when the headset is connected.

- Press **TALK** to answer or place a call while using the headset.

### Belt clip installation

- Attach the belt clip by inserting the sides of the belt clip into the slots.
- Snap the ends of the belt clip into place.

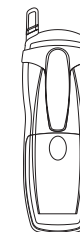
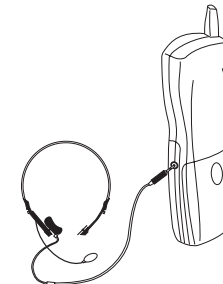



## LCD SCREEN MESSAGES

The following indicators show the status of a message or of the phone.

### ERROR

Caller information has been interrupted during transmission or the phone is excessively noisy.

### ENTER NAME

Prompt telling you to enter name in directory.

### DELETE ALL?

Prompt asking you if you want to erase all Caller ID entries.

### DELETE?

Prompt asking you if you want to erase the current Caller ID entry or a directory entry that is shown on the screen.

### END OF LIST

Indicates that there is no additional information in Caller ID list.

### NEW

Indicates call or calls have not been reviewed.

### UNKNOWN NUMBER/UNKNOWN NAME/UNKNOWN CALLER

The incoming call is from an area not serviced by Caller ID, or the information was not sent.

### PAGING

Someone has pressed the **PAGE/INTERCOM** key on the base or the **INT** key on the handset.

### BLOCKED NUMBER/BLOCKED NAME/BLOCKED CALLER

The person is calling from a number that has been blocked from transmission.

### NO DATA

No Caller ID information was received.

## SOUND SIGNALS

A long warbling tone	Signals an incoming call
Single Tone	A key is pressed
Two Long Beeps	Confirmation tone
One short beep and one long beep	Page signal
Three short beeps	Error tone/Out-of-range warning
4 short beeps every 7 seconds	Low battery warning

## TROUBLESHOOTING

### CALLER ID

#### No Display

- Is battery fully charged? Try replacing the battery.
- Make sure that the base is connected to a non-switched AC outlet. Disconnect the base from the plug and plug it in again.
- Did you order Caller ID service from your local telephone company? The display will not work unless you order Caller ID service from your phone company.

#### Caller ID Error Message

- The phone displays this message if it detects anything other than valid Caller ID information during the silent period after the first ring. This message indicates either the presence of noises on the line, or that an invalid message has been sent from the telephone company.

### TELEPHONE

#### No dial tone

- Check installation:
  - Is the base power cord connected to a working outlet?
  - Is the telephone line cord connected to the base unit and the wall jack?
- Disconnect the base from the wall jack and connect another phone to the same jack. If there is no dial tone in the second phone, the problem might be your wiring or local service.
- Is the handset out of range of the base?
- Make sure the battery is properly charged (12 continuous hours).



## TROUBLESHOOTING

- Is the battery pack installed correctly?
- Did the handset beep when you pressed **TALK/CALL BACK**? Did the **VOICEMAIL/IN USE** indicator come on? The battery may need to be charged.

### Dial tone is OK, but cannot dial out

- Make sure the **TONE/PULSE** switch on the back of the base unit is set to TONE or PULSE according to your phone service.

### Handset does not ring

- Make sure the **RINGER** switch on the handset is turned to ON.
- You may have too many extension phones on your line. Try unplugging some phones.
- See solutions for **No dial tone**.

### You experience static, noise, or fading in and out

- Change channels.
- Is handset out of range? Move closer to the base. If you hear 3 short beeps when you press **TALK**, you are out of range.
- Does the base need to be relocated?
- Charge battery.
- Make sure base is not plugged into an outlet with another household appliance.

### Phone beeps

- Place handset in base for a minimum of 20 seconds to reset the security code. If that does not work, charge battery for 12 continuous hours.
- Clean charging contacts on handset and base with a soft cloth, or an eraser.
- See solutions for **No dial tone**.
- Replace battery.

### Dialing from directory

- Did you program the directory keys correctly?
- Did you follow proper dialing sequence?
- Make sure the **TONE/PULSE** switch is set to TONE or PULSE according to your phone service.
- Did you reprogram directory after power outage or battery replacement?

## TROUBLESHOOTING

### VOICE MAIL/IN USE indicator on the base flashes

- Provided your phone company offers voice mail indicator service and you subscribe to it, **VOICE MAIL/IN USE** indicator flashes when the phone is not in use to indicate there is a message waiting. It stops flashing after the message has been reviewed.

### Causes of poor reception

- Aluminum siding.
- Foil backing on insulation.
- Heating ducts and other metal construction can shield radio signals.
- You are too close to appliances such as microwaves, stoves, computers, etc.
- Atmospheric conditions, such as strong storms.
- Base is installed in the basement or lower floor of the house.
- Base is plugged into an AC outlet with other electronic devices.
- Baby monitor is using the same frequency.
- Handset battery is low.
- You are out of range of the base.

## MAINTENANCE

To keep your telephone working and looking good, follow these guidelines:

- Avoid putting the phone near heating appliances and devices that generate electrical noise (for example, motors or fluorescent lamps).
- Do not expose to direct sunlight or moisture.
- Avoid dropping the phone, and other rough treatment to the phone.
- Clean the phone with a soft cloth.
- Never use a strong cleaning agent or abrasive powder because this will damage the finish.
- Periodically clean the charge contacts on the handset and base with a clean pencil eraser.
- Retain the original packaging in case you need to ship the phone at a later date.

## MAXIMIZE BATTERY PERFORMANCE

The freedom that your cordless telephone can offer is fully dependent on the performance of the rechargeable battery in the handset. To maximize the battery performance, follow these guidelines:

### Charge it for a full 12 hours

Before initial use of your new battery, charge it for 12 hours continuously. The proper initial charging is very important to maximize the battery performance.

### Keep the contacts clean

You can never fully recharge the battery if the contacts are dirty. Clean all the contacts – two at the bottom of handset and two in the base cradle – periodically using a pencil eraser.

### Do not replace the handset in the base after each call

Repeated short charging creates a memory effect in the battery. Once a rechargeable battery acquires this “short memory”, it sends a “low battery” signal even when it is almost fully charged. The battery then needs to be charged frequently. To avoid this, leave the handset away from the cradle until it really needs recharging.

### Refresh battery

If your battery seems to need recharging more often than usual, it may have lost part of its charging capacity because of premature recharges. To bring back its full capacity, try “refreshing” the battery:

1. First discharge the battery by leaving the handset in TALK mode until Battery Low indication turns on. (Disconnect the base from the telephone line, so that your line is not busy all the time.)
2. Then charge it for 12 continuous hours.
3. Repeat the above once more.

## TECHNICAL INFORMATION

### REN Number:

The Ringer Equivalence Number (REN) assigned to each terminal device provides an indication of the maximum number of terminals allowed to be connected to a telephone interface.

The REN number of this phone is located on the bottom of the base unit. The termination on an interface may consist of any combination of devices subject only to the requirement that the sum of the Ringer Equivalence Numbers of all the devices does not exceed 5.

### CAUTION

This product is intended for use in CANADA only. Sale or use in other countries may violate local laws.

Cordless telephones use radio frequencies to allow mobility. This affects the performance of your phone.

### 1. NOISE

Electrical pulse noise is present in most homes at one time or another. This is most intense during electrical storms. Certain kinds of electrical equipment, such as light dimmers, fluorescent bulbs, motors, fans, etc., also generate pulse noise.

Because radio frequencies are susceptible to this, you may on occasion hear pulse noise through the handset. This is usually only a minor annoyance and should not be interpreted as a defect of the phone.

### 2. RANGE

Because radio frequencies are used, the location of the base station can affect the operating range of the phone. Try several locations and choose the one that gives the clearest signal to the handset. (Turning in a circle while holding the handset may also increase the operating range.)

### 3. INTERFERENCE

Electronic circuits activate a relay to

connect the unit to your telephone line. These electronic circuits operate in the radio frequency spectrum. While several protection circuits are used to prevent unwanted signals, there may be periods when these unwanted signals enter the base station. You may hear click or hear the relay activate when you are not using the cordless handset. If this occurs frequently, you can minimize or eliminate the problem by lowering the height of the base station or relocating the base station. It may also be helpful to change the operating channel and/or the security code setting.

Operation is subject to the following two conditions: (1) this device may not cause interference, and (2) this device must accept any interference, including interference that may cause undesired operation of the device.

### NOTICE:

Privacy of communications may not be ensured when using this telephone. Other devices, including other cordless telephones, may interfere with the operation of this cordless telephone or cause noise during operation. Units without coded access may be accessed by other radio communication systems. Cordless telephones must not cause interference to any licensed radio service.

The Industry Canada Label identifies certified equipment. This certification means that the equipment meets certain telecommunications network protective, operational and safety requirements. The ministry does not guarantee that the equipment will operate to the user's satisfaction.

Before installing this equipment, users should ensure that it is permissible to be connected to the facilities of the local telecommunications company. The equipment must also be installed using an acceptable method of construction.

## TECHNICAL INFORMATION

In some cases, the company's inside wiring associated with single-line individual service may be extended by means of a certified connector assembly (telephone extension cord). The customer should be aware that compliance with the above conditions may not prevent degradation of service in some situations.

Repairs to certified equipment should be made by an authorized Canadian maintenance facility designated by the supplier. Any repairs or alterations made by the user to this equipment, or equipment malfunctions, may give the telecommunications company cause to request that the user disconnect the equipment.

The user should ensure for his own protection that the electrical ground connections of the power utility, telephone lines and internal metallic water pipe system, if present, are connected together. This precaution may be particularly important in rural areas.

### CAUTION

Users should not attempt to make such

connections themselves, but should contact the appropriate electrical inspection authority, or electrician, as appropriate.

The exclamation point within an equilateral triangle is intended to alert the user to the presence of important operating and maintenance (servicing) instructions in the literature accompanying the product.

This symbol on the product is used to identify the following important information. Use only with specified SANYO power adaptor.

**NOTICE:** This equipment meets the applicable Industry Canada Terminal Equipment Technical Specifications. This is confirmed by the registration number. The abbreviation, IC, before the registration number signifies that registration was performed based on a Declaration of Conformity indicating that Industry Canada technical specifications were met. It does not imply that Industry Canada approved the equipment.

Canada Inc. will repair, or at our option, replace a Communications product which shows evidence of a manufacturing defect in materials or workmanship. Replacement PARTS are warranted for the remaining portion of the warranty period.

### WHAT IS NOT COVERED

- Communications products purchased outside Canada.
- Communications products purchased in a used condition.
- Communications products purchased from non Sanyo-authorized dealer.

## SANYO COMFORT WARRANTY

### WARRANTY APPLICATION

Sanyo Communications products purchased new, unused in Canada through a Sanyo Authorized Dealer are warranted against manufacturing defects in materials and workmanship for ONE YEAR covering parts and labour, from the date of purchase by the original retail purchaser. This warranty only applies in favour of the original retail purchaser of the warranted product.

### SANYO CANADA INC.'S RESPONSIBILITY

During the warranty period, SANYO

## SANYO COMFORT WARRANTY

- Communications products not intended for Canadian usage or products without appropriate Canadian regulatory approvals.
- Problems due to product set-up and installation.
- Adjustments that are outlined in the Operating Manual.
- Accessory items including antenna, and batteries,
- Damage in or due to transportation.
- Damage due to improper maintenance, accident, abuse, misuse or negligence.
- Damage caused by lightning and power surges.

### ORIGINAL RETAIL PURCHASER'S RESPONSIBILITY

You, the original retail purchaser, must present your original, dated bill-of-sale together with this warranty to SANYO Canada Inc. or to an authorized Sanyo Service Depot when you make a claim under this warranty.

You, the original retail purchaser, are responsible for any costs of TRANSPORTING the product to and from SANYO Canada Inc. or an authorized Sanyo Service Depot. You also are responsible for the cost of any MAINTENANCE necessary in respect of the product.

### WARRANTY BECOMES VOID

This warranty becomes void if the product's serial numbers are altered or removed or if any repair to the product is made other than by SANYO Canada Inc. or by an authorized Sanyo Service Depot.

### LIMITATIONS

- SANYO Canada Inc. reserves the right to change or improve the design of the model of the product warranted hereunder without incurring any obligation to make any modifications to or to install any improvement in or on the product.
- In no event shall SANYO Canada Inc. or any of its Authorized Dealers be liable for special or consequential damage arising from the use of this product.

### STATUTORY WARRANTIES

The above provisions do not preclude the operation of any applicable provincial statute which in certain circumstances may not allow some of the limitations and exclusions described in this Warranty. Where any terms of this Warranty are prohibited by such a statute, they shall be deemed null and void but the remainder of this warranty shall remain in effect.

### HOW TO OBTAIN WARRANTY SERVICE

Please contact the Sanyo Authorized Dealer from whom the product was purchased, or contact us directly at:

**SANYO Canada Inc.**

**1-300 Applewood Cres.  
Concord, Ont. L4K 5C7**

**(905) 760-9944**

**1-800-263-2244**

## SOS HELP LINE

At Sanyo, fulfilling the needs of our customers is a priority. That's why we created our SOS customer service program that guarantees satisfaction.

### **NATIONWIDE CUSTOMER SUPPORT**

SOS is there to help you. Our friendly and knowledgeable product specialists will quickly answer your questions about setup and use of Sanyo telephone products. Simply call toll free from anywhere in Canada to connect to our no-charge, SOS support and service network:

**1-800-263-2244**

**between 8:30 am – 7:00 pm EST**

Or visit our website at [www.sanyoservice.com](http://www.sanyoservice.com), and click the **Customer Relations** button to get access to our FAQ's (Frequently Asked Questions) and other helpful features.

### **STAY-AT-HOME CONVENIENCE**

It's a nuisance making another trip to the store when you're stuck. Now with SOS, all that's necessary is a quick call from your home for product assistance.

### **HASSLE-FREE EXCHANGE**

Should your Sanyo telephone require servicing due to a manufacturing defect during the warranty period, SANYO Canada will ship prepaid a replacement unit\* within two business days after receiving your defective unit. **Consumers are responsible for the shipping costs of the unit back to Sanyo.**

- For older, non-current models, replacement units may not be available, in which case our regular warranty conditions will apply.

### **GUARANTEED QUALITY**

All SOS replacement sets are checked and serviced by factory-authorized technicians before being sent out. SOS means you never have to worry.

C.O.D. and/or Collect shipments will not be accepted.

Unit must be returned to Sanyo in its original box with all accessories, i.e.: owner's manual, battery, adaptor, telephone cord, etc.